

# Operator's manual



**Basic machine  
City Ranger 2260**

# Introduction

## Dear Customer

### **Congratulations with your Egholm product**

The City Ranger 2260 is a Danish designed and manufactured product which offers a very flexible way of maintaining outdoor areas.

### **Optimal use of your Egholm utility machine**

To ensure optimal performance of your Egholm utility machine, please read this manual carefully before using the machine. Failure to do so can result in personal injury and damage to the machine.

### **Safety**

The utility machine is equipped with various devices to ensure optimal operational safety both for the user and the surroundings. We ask you to pay particular attention to section 1.1 Safety. The machine must only be serviced by professionals.

The City Ranger 2260 is designed only for use by professionals. On delivery, the user will receive thorough training to become a competent operator.

Do not lend the machine to anyone who has not been thoroughly trained and has not read this manual carefully.

The operator's manual should be considered as a permanent part of the machine and so must remain with the machine if it is sold.

### **Warnings**

Some items in this operator's manual are marked with this warning symbol.

The warning indicates areas where extra care has to be taken to avoid personal injury or damage to the machine and its accessories. The warning also shows what you should pay special attention to.



### **Reservations**

As it is the Egholm policy to make continuous improvements, we reserve the right to alter the specifications and equipment at any time without notice. Egholm accepts no liability for errors or omissions in the operator's manual.

### **Contact us**

Should you have any questions regarding your Egholm product, do not hesitate to contact Egholm.

### **Best regards**

Egholm A/S · Transportvej 27 · DK-7620 Lemvig

T. +45 97 81 12 05 · F. +45 97 81 12 10

E-mail: [info@egholm.dk](mailto:info@egholm.dk) · [www.egholm.eu](http://www.egholm.eu)

Introduction .....	5
General information .....	7
1.1 Safety .....	7
1.2 Attachments .....	12
1.3 EC Declaration of Conformity .....	13
1.4 Technical data .....	14
1.5 Access to the cab .....	17
1.6 Steering column .....	18
1.7 Operational features .....	21
1.8 Joystick console .....	22
1.9 Pedals .....	24
1.10 Start/stop function for salt and sandspreader .....	25
1.11 Fuses .....	26
1.12 Towing .....	28
1.13 Front attachment frame – A-frame .....	29
1.14 Rear attachment frame – B-frame .....	29
1.15 Cab seat – mechanical or pneumatic suspension .....	30
1.16 Cab heating .....	31
1.17 Cab ventilation .....	31
1.18 Air conditioning .....	31
1.19 Opening and removing side screens .....	32
1.20 Opening the loading frame .....	33
1.21 Removing the cab/roll bar .....	34
1.22 Fitting the cab/roll bar .....	36
1.23 Trailer .....	38
Operator's manual .....	40
2.1 Daily checks before start-up .....	40
2.2 Start, drive and stop .....	42
2.3 Transporting the City Ranger 2260 .....	45
Service and maintenance .....	47
3.1 Daily maintenance .....	47
3.2 Lubrication .....	49
3.3 City Ranger 2260 service and maintenance chart .....	50
3.4 Hydraulic system .....	52
3.5 Engine maintenance .....	53
3.6 Fuel .....	55
3.7 Cooler .....	56
3.8 Air filter .....	57
3.9 Windscreen washer liquid .....	57
3.10 Battery .....	58
3.11 Generator V-belt .....	59
3.12 Removal of wheels .....	59
3.13 Cabin filter .....	60
3.14 In case of failure .....	61
3.15 Storage .....	61
Conditions .....	63
4.1 Warranty .....	63
4.2 Complaints .....	64
4.3 Disposal .....	64
Wearing parts .....	66
5.1 Wearing parts - City Ranger 2260 .....	66
Notes .....	68

# Introduction

**Honest  
Machines**

## **The utility machine City Ranger 2260**

The City Ranger 2260 is an outdoor utility machine with a complete range of special attachments that allows you to work outdoors, all year round. Sweeping and vacuuming in spring and autumn, mowing grass and lawn-edge cutting in the summer, sweeping snow, and spreading gravel and sand in the winter. The City Ranger 2260 is market tested, effective and professional. Designed for versatility, this user-friendly machine is extremely reliable and exceedingly comfortable to operate.

## **Quick-shift of attachments**

Attachments can be changed quickly and easily. The new attachment system has a single lock and release lever. Use the lever – one click and the attachment is on in less than a minute. Hoses and couplings are hidden (thus well-protected) and the hydraulics and water supply, power and vacuum hoses connect automatically.

## **Maintenance**

Open a single side cover to check the water, oil, air filter and battery. No need to remove attachments.

## **Environment**

The City Ranger 2260 is environmentally sound – today and tomorrow. Quiet when operating and practically vibration-free. The machine can use biological hydraulic oil and is far less harmful to the environment than the minimum levels set by the EU.

## **Comfort**

The City Ranger 2260 is an ergonomically-designed outdoor utility machine. The cab is spacious, with good visibility on all sides, and the entry-opening is low and wide. The wheel and seat are fully-adjustable to suit the operator. The seat has suspension (with optional pneumatic suspension) and is very comfortable. All the operating controls – including the joystick for controlling the attachments – are positioned optimally for the operator. Optional air conditioning.

## **Publication**

This manual is made in accordance with the requirements in standard ISO 3600:1996.

To order this manual please refer to this item number E50006724. This manual applies only to the Egholm City Ranger 2260.

# General information

**Honest  
Machines**

## 1.1 Safety

In this chapter safety instructions are described in order to ensure safe operation. Special attention should be taken to read and fully understand the contents of this chapter. Any person who has not read and fully understood the contents of this chapter must not be allowed to operate the Egholm City Ranger 2260.



### Avoid roll-overs

Do not drive the machine in a place where it can slide, tip or roll. Use the machine on a solid and regular ground. Do not drive on slopes with an incline of more than 10°. (Picture 1)

Do not drive on slopes with an incline of more than 21° when driving for more than 10 min.

Continuous driving: Do not drive on slopes with an incline of more than 12°. (Picture 2)

The following situations are known to cause more instability in the machine and care should be taken by the operator to assure safe operation:

- Emptying the hopper on an incline.
- Manoeuvring the machine with raised hopper.
- Abrupt steering.
- Manoeuvring with speed, on a slope or with weight on A-frame/B-frame.
- Manoeuvring the machine on an irregular ground.
- Low tire pressure.
- Considerate driving is recommended.



### Avoid standing close to the machine while it is in use

Make sure that no person is near the machine while it is in use as there is a danger of collision. (Picture 3)



### Attention

As it is articulated, the rear end of the machine swings out when turning. Make sure that no one is standing near the machine while it is in use. (Picture 3)



①

Do not drive on slopes with an incline of more than 10°



②

Driving up to 10 min: no more than 21° incline  
Continuous driving: no more than 12° incline



③

Prevent people from standing in the working area

# General information

## 1.1 Safety - continued



### Avoid crushing

Make sure that nobody puts their hands, feet or any limb close to the mobile or articulated parts of the vehicle. (Picture 1+3)



### Do not inhale exhaust gas

Exhaust gas is hazardous to health and can even be fatal. If the machine is run in a confined space, the exhaust gas must be adequately ventilated out of the room or area, using an exhaust hose, for example. Otherwise doors and windows must be opened to allow fresh air inside.



### Exhaust pipe line

Do not touch any part of the exhaust system (pipe line or the catalyst) as it becomes very hot when the machine is running. (Picture 2)



### Hydraulic components

Be aware that the hydraulic components may get hot when the machine is in use.



### Mount/Dismount of attachments

Mount or dismount attachments on a flat or stable ground only.



### A-frame

Keep fingers and hands away from the A-frame as there is a danger of crushing.



### Turn the steering wheel carefully

The City Ranger 2260 is articulated – it turns sharply, immediately. (Picture 3)



### Other hazards

There may be other circumstances and situations than those mentioned above where it may be dangerous to use the City Ranger 2260.



Avoid crushing fingers



Exhaust pipe



Articulated joint



## 1.1 Safety - continued



**Attention**  
**Take care while handling**  
**potentially dangerous products**



**Attention**  
Gasoline is highly flammable.

- Do not smoke when filling up.
- Do not spill gasoline on the engine, the mechanical parts or the vehicle body.
- The acid contained in the battery is very harmful and very corrosive. Avoid contact with skin and eyes. In case of contact, rinse thoroughly with clear water.
- In case of critical injuries, seek medical help.

# General information

## 1.1 Safety - continued

### Environment

Please consider the environment when any of the various fluids (brake liquid, battery liquid, hydraulic fluid, gasoline, oil, and cooling water) should be discharged. Always discharge in accordance with local regulations.



### Operation instructions

- Always watch out for the traffic while operating the machine.
- The City Ranger 2260 belongs to the category of public work vehicles. This vehicle should not be used for the transport of humans or goods.
- Climbing up curbs is possible up to 15 cm from the ground (traditional pavements) and should be done very slowly.
- Remove the ignition key when leaving the machine in order to avoid unauthorized use.

### Maintenance

The company Egholm is by no means responsible for damages or accidents caused by misuse or by a lack of maintenance of the vehicle. When non-original spare parts are used, or attachments or other components are used which are not approved by Egholm, the guarantee will not apply.



- When ever working on the machine, switch off the engine, take out the key and switch of the main switch
- Only work in the engine compartment when engine is turned off and cooled. Keep a safe distance and wear safety glasses.
- Never put your hands in or near the cooling fan when it is running. (Picture 1)

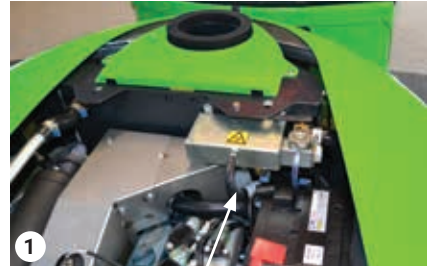

Cooling fan

## 1.1 Safety - continued

### Safety signs

The machine is equipped with two safety signs located in the articulation joint on the front frame. One on each side.

The sign says that activities around the articulation point are forbidden.

The sign must be kept clean and visible at all times. If sign is missing or illegible it is the owner's responsibility to ensure that it is replaced. For ordering replacement please refer to item number E03001450. (Picture 1)



1 Articulation joint warning

### Drive pedal information

Pedal movements:

Forward: Push the pedal down:  
The machine drives forward.  
(Picture 3)

Stop: Neutral position.

Reverse: Press left and down  
The machine reverses.  
(Picture 4)

Speed is variably adjusted. See section 1.9.

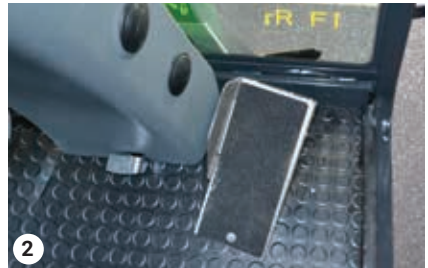

2 Drive pedal



3 Forward driving



4 Reverse driving

# General information

## 1.2 Attachments

City Ranger 2260 is designed to work with the following attachments:

<b>Attachments</b>	<b>Type</b>
Suction Sweeper - Hopper	FST2250
Suction Sweeper - Front brushes	4FS2250
Suction Sweeper - Side brush	FSS2250
Mulch mower/Rotary mower 1200	22DLM1200
Mulch mower/Rotary mower 1600	22LM16
Grass collector	22GOT
Flail mower / Verticutter	22SLK
Weed brush	22UKB2250
Dozer blade	22DZ13
Hedge trimmer	HK1300MINI/2250
Lawn edger	22VKS1
Salt and sand spreader	22SG
Snow sweeper	22SK120
Tipping shovel	22VS200
Snow V-blade	GMR
Snow blower	Rapid 1565/1566

There is an operator's manual for each attachment.

Operation with these attachments must follow the instructions outlined in the relevant operator's manual. Do not operate the City Ranger 2260 with the attachment unless all instructions have been followed.

## 1.3 EC Declaration of Conformity

Manufacturer: **Egholm A/S**  
Address: **Transportvej 27 · DK-7620 Lemvig**  
Telephone: **+45 97 81 12 05**

hereby declares

that **City Ranger 2260**  
Serial no.: **UHM 2260 G0 (manufacturing year)**  
**A XXXXX (serial number)**

has been manufactured in conformity with the provisions of Regulation (EU) 167/2013 and Directive 2006/42/EC

Any alteration, rebuilding or addition of implements, accessories or other equipment not manufactured by Egholm automatically results in the cancellation of type approval, CE approval, any other approval, as well as any warranty on machine and attachments.

Unless otherwise agreed in writing between the operator, customer and Egholm, Egholm is the data originator (data originator) of all data generated by the machine and attachments during use.

Person authorized to compile the technical documentation:  
Rainer Flanz  
Egholm A/S  
Transportvej 27 · DK 7620 Lemvig

Place: Lemvig  
Date: \_\_\_\_\_  
Signature:   
Rainer Flanz, R&D Manager

# General information

## 1.4 Technical data

### Dimensions

Length (L) .....	2,500 mm
Width (W) .....	1,068 mm
Height with cab .....	1,939 mm
Height including roll bar .....	2,060 mm
Max. speed .....	20 km/h

### Weight

Machine weight (including cab) .....	940 kg
Unladen weight - City Ranger 2260 with roll bar .....	910 kg

### Max. permitted weight

Utility machine .....	1,610 kg
Machine and trailer without brakes .....	2,050 kg
Machine and trailer with overrunning brakes .....	2,500 kg
Trailer without brakes .....	750 kg
Trailer with overrunning brakes .....	1,610 kg
Max. vertical load on coupling point .....	100 kg
Permitted axle load, front .....	900 kg
Permitted axle load, back .....	900 kg

### Tyre

Tyre size .....	20x10.00-10,6PLY
Tyre pressure .....	2.8 bar or 40 PSI
Tyre max. load .....	536 kg

### Engine

Type/manufacturer .....	Kubota
Type .....	WG972-G-E4
Engine power, Gross .....	24.2 kW (32.3 HP) at 3600 rpm
Engine power, Net .....	23.1 kW (30.8 HP) at 3600 rpm

Cylinders .....	3
EU norm. ....	Stage V

Refer to the engine operator's manual for further technical data.

## 1.4 Technical data - continued

### Fuel

Fueltype. ....	Gasoline
Fuel tank capacity. ....	45 l

### Engine lubricating system

Lubricating system. ....	Pressure-lubricating system with filter
--------------------------	---

### Lubricants

Engine oil approx. ....	3.4 l, synthetic SAE 10W-30
.....	Engine oil should have properties of API classification SL or higher
Air filter. ....	Dry, replaceable filter
Cooling system. ....	Liquid coolant

### Electrical system

Start system. ....	Electrical starter
Charging system. ....	Generator
Charging capacity. ....	12V, 60 A
Battery. ....	12V, 55 Ah battery

### Hydraulic oil

Type. ....	Texaco Rando HDZ 68
Tank capacity. ....	21 l

### Brakes

Service brakes. ....	Drum brakes on front wheels
Parking brakes. ....	Friction brakes on front wheels
Emergency. ....	Hydrostatic braking

### Sound measurements

- in accordance with Regulation (EU) 2018/985 Annex II

With cab:

• Stationary. ....	81 dB(A)
• In motion. ....	81 dB(A)

- in accordance with Regulation (EU) 1322/2014 Annex XIII, Test method 2

With cab:

• Operator seat, open windows. ....	88 dB(A)
• Operator seat, closed windows. ....	85 dB(A)

With roll bar:

• Operator seat. ....	87 dB(A)
-----------------------	----------

# General information

## 1.4 Technical data - continued

### Vibration test

Egholm can declare that if the machine is used according to these instructions, the vibrations do not cause dangerous situations.

Whole body, EN 13059, daily exposure . . . . . 0.29 m/s<sup>2</sup>

Hand/arm, EN 13059, daily exposure . . . . . 0.25 m/s<sup>2</sup>

Seats mounted for vibration test: . . . . . COBO SC79-M97 or SC79-M200

Both seats are approved according Directive 78/764/EEC.

### Cab

#### Falling Object Protective Structure - FOPS

The City Ranger 2260 and its attachments do not operate with processes where falling objects are a risk

#### Roll-Over Protective Structure - ROPS

Tested according to Directive 86/298/EEC and fulfills OECD

Code7

#### Contact with Hazardous Substances

The air intake contains a filter to protect the driver against dust inhalation. The filtration class, according to EN 779, is F8.

Cab classification according EN 15695-1 is Category 1.

This cab category does not provide protection against hazardous substances.

City Ranger 2260 fitted with this cab shall not be used under conditions requiring protection against hazardous substances.

#### Turning radius

Turning circle inside/outside . . . . . 600/1,640 mm

#### Information plate

Mounted on the right side of the front chassis

#### Operating City Ranger 2260

**There is no need for special tools to operate the City Ranger 2260**

#### Attention

Specifications may change without notice.



## 1.5 Access to the cab

Access to the cab is from the left side door. The door is opened by pressing the button on the handle. (Picture 1)

To enter the cab, simply step directly in. (Picture 2)

To leave the cab, the door is opened by pressing the internal handle. (Picture 3)



Button on door handle



Cab floor



Internal door handle



### Attention

There is a similar door on the right side. This door is operated in the same way as the left door and can be used as an emergency exit.



### Attention

Always lock the machine when leaving. Never leave keys in ignition lock.



### Attention

Keep cabin free of loose items that may interfere with safe operation of the machine.

# General information

## 1.6 Steering column



### Ignition lock and light switch

1. Ignition lock.
2. Position light/0/light switch.
3. Instrument panel.

### Automatic alarm

Turning the ignition key activates the alarm for two seconds, followed by one second pause and activation for two seconds. When the alarm sounds it is repetitive, 2 seconds beep, 30 seconds pause (max 3 beeps).

## 1.6 Steering column - continued

### Instrument panel

4. Engine malfunction indicator light (MIL).

5. Parking brake indicator.

6. Charging light.

Normally lights on ignition or when the engine starts. If the light stays on, stop the engine and find the cause. Check the generator belt.

7. Dimmed headlight indicator.

8. Turn signal indicator.

9. Hydraulic filter alarm (when lit indicates filter must be replaced) or hydraulic oil low: Hydraulic oil required.

The alarm device must be deactivated when the temperature falls to under +5 °C. Check oil level. If this is OK, restart the machine. The alarm device must deactivated after no more than 15 seconds.

10. Engine oil alarm.

**If the light is on during operation, stop the engine immediately and check the engine oil level.**

**If the oil is low, it must be topped-up immediately**

11. Water temperature alarm.

If on it indicates the engine temperature is too high. Switch off all attachments and let the engine run on half-power (rpm) for approx. two minutes. If necessary, clean the radiator grills. The operating hydraulics will automatically disconnect when the overheating alarm device is activated.

12. Air filter blockage alarm (optional).

13. Fuel tank indicator. Lights up when there is less than five litres of fuel left in the tank.

14. Fuel tank level.

15. Time/rpm/speed counter. Time shown on start-up automatically switches over to show rpm.

16. Shows rpm or km/h / mph

17. Engine temperature indicator.

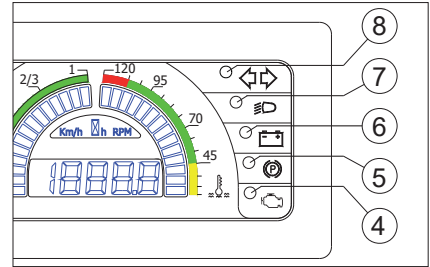

Instrument panel – right

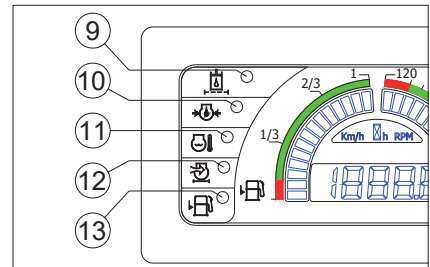

Instrument panel – left

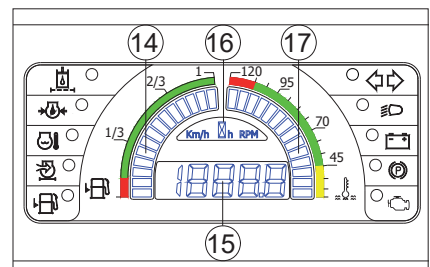

Instrument panel – centre

**Sound alarm activates in case of 6, 9, 10, 11, 12 and 13**

# General information

## 1.6 Steering column - continued



18 23 19 20 21 22 24

### Steering column

18. Instrument panel press to switch between rpm and km/h.

19. Turn signal switch/arm.

20. Horn switch.

21. Transport lock (disengaged position).

ON: Handle must be moved up to the highest position. As the A-frame lifts, the transport lock is automatically activated. OFF: Unhitch the handle and lift the A-frame to the uppermost position. The attachment can now be lowered again.

22. Parking brake.

The parking brake is engaged by: Press the brake pedal all the way down. Lift the handle up. Release the brake pedal again. To disengage the parking brake: Press the brake pedal. This frees the handle.

23. Turn signal, trailer.

24. Steering system failure (low steering oil pressure).

## 1.7 Operational features

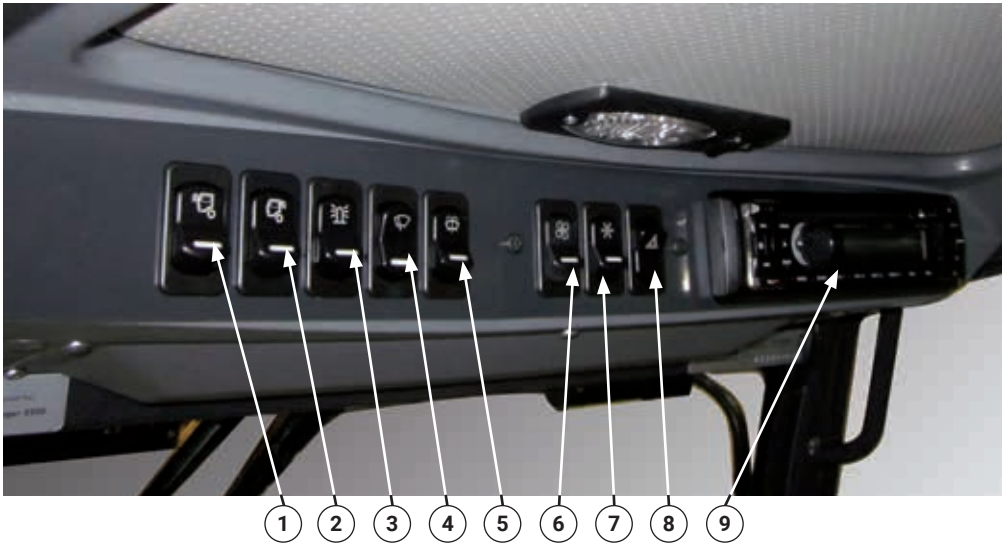

1. Work light, front.
2. Work light, rear.
3. Rotary light. (0 -1-2)\*
4. Windscreen wipers / Interval wiper.
5. Washer.
6. Fan heater.
7. Air conditioning (option).
8. Hazard lights.
9. Bluetooth radio with USB port and SD slot (option).

\* In position 1 (the middle position), the switch turns the beacon on.  
In position 2, the LED blitz front (option) turns on together with the beacon.  
Attention! The LED blitz must not be on during transport on public roads.  
Check the local regulations for use of LED blitz in working situations.

# General information

## 1.8 Joystick console

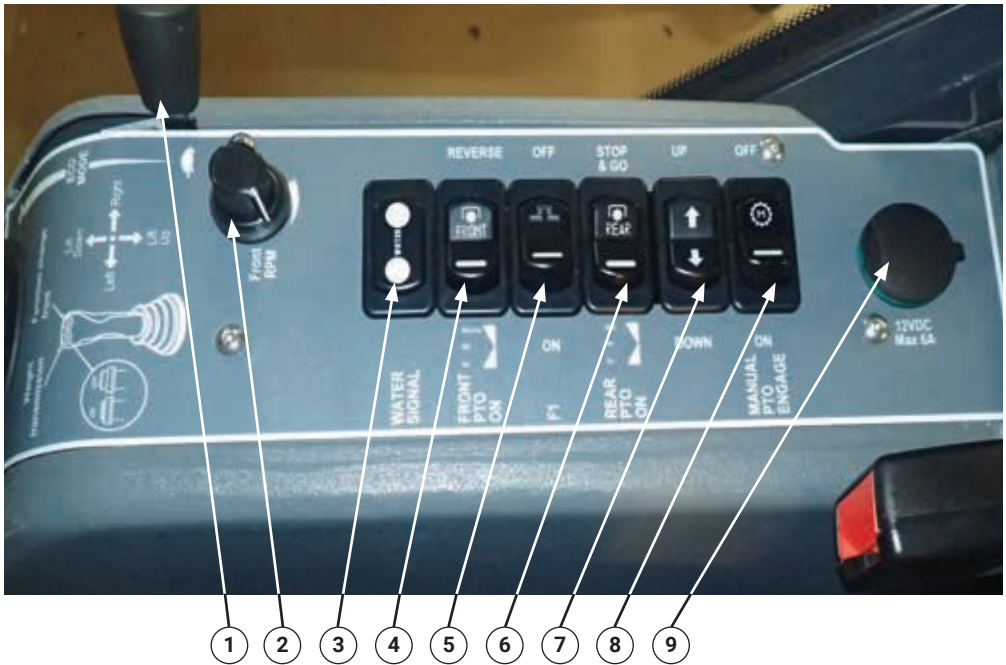

1. Throttle.

2. Front attachment speed adjustment (attachment specific).

3. Lamp indicator for water supply on suction sweeper hopper.

4. PTO front: Press left for "on", middle position for "off" and right for reversing.

5. Function (F1), (attachment specific, See the attachment operator's manual).

6. PTO rear: Press left for "on", middle position for "off" and right for start/stop function "Stop & go".

7. Function. (F2), (attachment specific, See the attachment operator's manual).

8. Manual start-up:

To start-up an attachment while not sitting in the cab, do the following:

A) Push the throttle all the way forward (full rpm).

B) Hold the switch (8) down, at the same time turning on the attachment (4) and/or (6).

C) Release the switch (8) after five seconds.

9. 12 V connector.

## 1.8 Joystick consol - continued



10 11 12 13 14 15

10. Joystick for A-frame.

To lift A-frame: move the joystick up.

To lower A-frame: move the joystick down.

Sideways movement of joystick is dependant on attachment.

11. Function-change switch for front attachment (attachment specific, See the attachment operator's manual).

12. Weight distribution ON/OFF switch.

13. Joystick for the rear attachment and hydraulics on the back end.

The functions are attachment-dependant. See the attachment operator's manual.

14. Adjusting weight distribution. Adjust the weight distribution until the attachment is weightless. Then adjust the weight transfer until the attachment touches and follows the ground. Adjust further for additional ground pressure from the attachment.

15. Safety cover for fuses.

# General information

## 1.9 Pedals

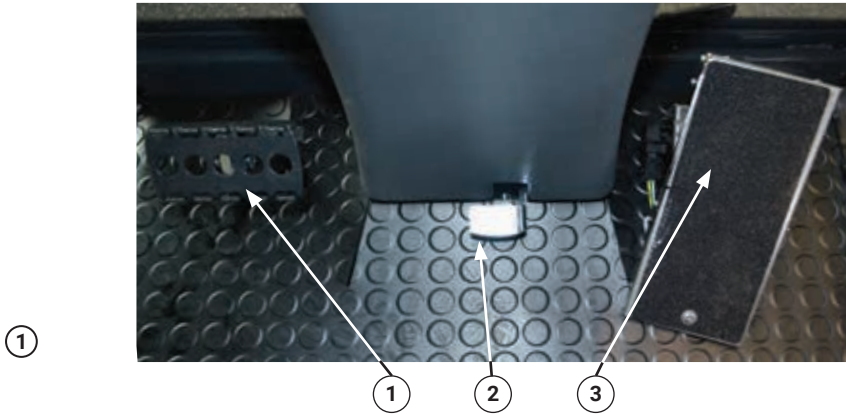

### 1. Brake pedal

Depress to brake.

When the brake pedal is pushed all the way down, the drive pedal is de-activated. Parking brake  
See section 1.6, point 22. (Picture 1)

### 2. Steering wheel pedal

Push pedal down to adjust steering wheel.  
(Picture 1)

### 3. Drive pedal

The speed of the machine is variably controlled by the throttle. When the drive pedal is engaged acceleration is automatic (engine rpm).

Forward: Push the pedal down:  
The machine drives forward.  
(Picture 2)

Stop: Neutral position.

Reverse: Press left and down  
The machine reverses.

The pedal automatically returns to the neutral position. (Picture 2+3)



Forward driving



Reverse driving



## 1.9 Pedals - continued

### Advice when driving on a steep slope

Users of City Ranger 2260 have reported that, from time to time, they feel that the machine does not accelerate properly when driving up an incline. The machine is designed to drive on an incline of no more than 12°. However, from experience we know that, under certain conditions, this machine can in fact cope with a steeper incline, max.21° max.10min. (Look at 1.1. Safety, page 7)

Egholm has the following advice when driving up a steep incline:

- Set the throttle to min. 2400 rpm.
- Then regulate the speed of the machine using the foot pedal.
- The function of the foot pedal can be compared to changing gear up or down. The more you press down on the pedal, the higher the gear - the less you press down on the pedal, the lower the gear.



Control panel



Stop and go switch

## 1.10 Start/stop function for salt and sandspreader

The start/stop function ensures that the spreading stops while the machine is stationary (PTO rear stops), so that the salt and sand spreader only spreads when the machine is in motion.

Activate the start/stop function on the control panel by pressing the PTO rear switch to the right ("Stop & go").

Deactivate the start/stop function by pressing the PTO rear switch back to neutral. (Picture 2)



### Remark

The start/stop function only operates the salt and sand spreader. If it is attempted used for other attachments, these attachments will stop when the machine is stationary.

# General information

## 1.11 Fuses

F 1	15 Amp	Front head lights.
F 2	7,5 Amp	Safety/brake contact, seat contact stop-lamp and PTO circuit. Supply Ass 17
F 3	15 Amp	Fan heater relay and A/C.
F 4	7,5 Amp	Weight distribution joystick, reverse alarm.
F 5	7,5 Amp	Wheel speed sensor, PTO front control, Engine rpm.
F 6	7,5 Amp	Display.
F 7	25 Amp	Reverse camera, relay fan / a/c supply, indication light. Supply Ass 16
F 8	20 Amp	Windscreen wiper and radio.
F 9	20 Amp	Beacon and working light.
F 10	7,5 Amp	A-frame switch and A-frame pole switch.
F 11	7,5 Amp	12V DC Output cab and AUX trailer plug.
F 12	10 Amp	Not in use
F 13	7,5 Amp	Emergency supply cab, left front position-light, left rear light, license plate light and ignition switch. Supply Ass 15.
F 14	7,5 Amp	Emergency supply steering column, right front position-light, right rear light and B-frame.
ASS 15	5 Amp	ECU starter switch
ASS 16.	Diode	Indication light, horn and steering column.
ASS 17	Diode	Stop fuel relay + starter
Spare 1	Spare fuse.	
Spare 2	Spare fuse.	

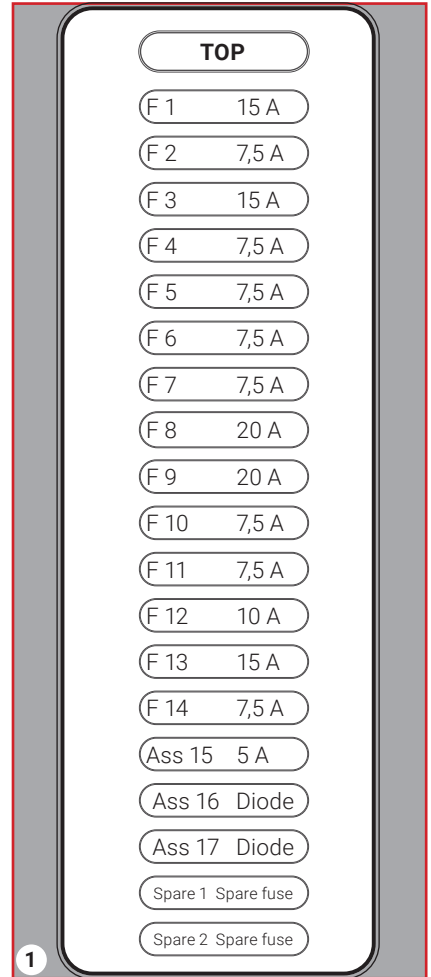

1

Fuses



2

Fuses – cabin floor right side

## 1.11 Fuses - continued

60 A JF15 generator  
60 A JF1 supply fuse box  
20 A JF2 emergency line  
30 A JF3 engine power

### Main switch

City Ranger 2260 will not start unless the main switch under the right rear screen is ON (vertical). (Pictures 2+3)

### Battery

When connecting or replacing the battery, be sure that the power cords are connected correct to the battery terminals.  
Be careful not to make any short circuit between the battery terminals.  
Clamp the battery so it is well fixed and put on the terminal protection covers.



### Warning

Always set main switch off when doing service on the machine.



① 60 A JF15 generator - 60 A JF1 supply fuse box  
20 A JF2 emergency line - 30 A JF3 engine power

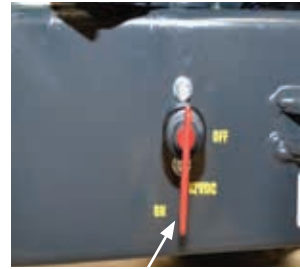

②

Main switch – ON



③

Main switch – OFF

# General information

## 1.12 Towing

### Towing

When towing City Ranger 2260, attach the tow line to the pull hook on the left side of the machine. (Picture 1)

### Towing valve

The towing valve under the machine is used to move the machine manually. (Picture 2)

To tow:

- Switch off engine.
- Turn valve until the lever is in the horizontal position (open position).
- Tow the machine.

When you have finished towing, turn the valve until the lever is in the vertical position.

The towing valve must be closed. If not, the machine will not run.



### Warning

Do not start the machine until the towing valve has been closed.



### Attention

When towing, there is no servo system.



### Attention

Always tow the machine at low speed.



Towing hook



Towing valve

## 1.13 Front attachment frame – A-frame

The A-frame locking handle must be in the unlock position if no attachment is attached. This protects the hydraulic couplings from dirt. (Picture 1)

### Connecting and disconnecting attachments

The engine must always be turned off before the attachment is connected/disconnected.

The quick-shift of attachments is not designed to be attached while the engine is running. Incorrect usage will destroy the couplings and will not be covered by the warranty.

The couplings and the area around the couplings must be kept clean to avoid an accumulation of dirt. (See section 3.1).

Attaching an attachment: see the attachment operator's manual.

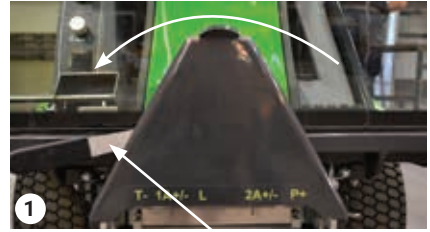

A-frame locking handle



B-frame locking handle



A-Coupling



B-Coupling



C-Coupling

## 1.14 Rear attachment frame – B-frame

The B-frame locking handle must be in the unlock position if no attachment is attached. (Picture 2)

### Connecting and disconnecting attachments

The engine must always be turned off before the attachment is connected/disconnected.

The quick-shift of attachments is not designed to be attached while the engine is running. Incorrect usage will destroy the couplings and will not be covered by the warranty.

The couplings and the area around the couplings must be kept clean to avoid an accumulation of dirt (See section 3.1).

Attaching an attachment: see the attachment operator's manual.

# General information

## 1.15 Cab seat – mechanical or pneumatic suspension

Adjust the seat to suit the driver.

### Mechanical

Height: Adjust using the handle 1.  
Anti-clockwise: higher.  
Clockwise: lower.

Weight: Adjust using the handle 2.  
Anti-clockwise: Softer suspension.  
Clockwise: Firmer suspension.

Forwards/backwards: Adjust using the handle 3.  
(Picture 1)

### Pneumatic

Higher: Adjust by gradually pressing the handle 1  
The suspension becomes firmer.

Lower: Adjust by gradually releasing the handle 1  
The suspension becomes softer.

Forwards/backwards: Adjust using the handle 2.  
(Picture 2)

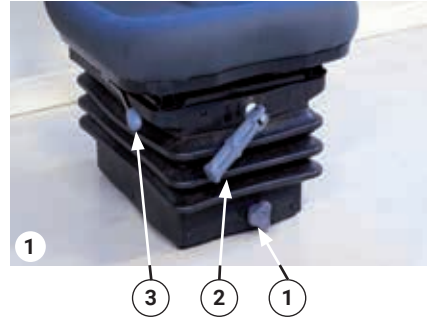

## 1.16 Cab heating

To switch on cab heating, turn the lever under the seat until it is parallel with the seat edge. (Picture 1)

The cabin fan must also be activated.

## 1.17 Cab ventilation

Open the air damper behind the seat to ventilate the cabin. Use the handle on the left side of the seat. Push the handle away from the seat to open the air damper. (Picture 2)

## 1.18 Air conditioning

Air conditioning can be used if the cabin is too warm and if the windscreen and windows steam up in humid weather conditions. This applies also during the winter months.

To activate the air conditioning, the cabin fan must be running at level 1 or 2.

It is recommended the air conditioning is serviced at least once a year, to ensure it operates optimally.

### **NB**

The condensate drain pipe must be checked/cleaned at each service or at least once a year. Failure to do so increases the risk of corrosion and bacterial accumulation in the system which can cause discomfort/sickness for the driver. Cabin filter must be checked/cleaned once a year.



Adjusting temperature



Recirculation handle

# General information

## 1.19 Opening and removing side screens

### Opening side screens

1. Put the release key into the slot. Put light pressure on the side screen and on the release key at the same time. Release key is in the key ring with ignition key. (Picture 1+2)

2. Open the screen.

### Removing the side screen

Lift the side screen off by pulling slightly upwards and remove the screens.

The machine is easier to service, when the side screen is removed. (Pictures 3)

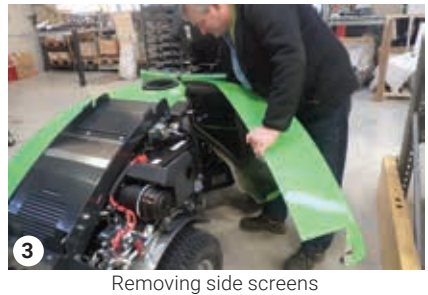



## 1.20 Opening the loading frame

The loading frame can be opened during general service.

1. Pull the release handle back. (Picture 1)
2. Pull the loading frame back all the way (until it cannot move further).



### Warning

Be carefull when running the engine when the loading frame is open. When the loading frame is open the exhaust from the exhaust pipe will heat up the loading frame. If running for a long time it can cause the wiring to melt. (Picture 2)



Release handle

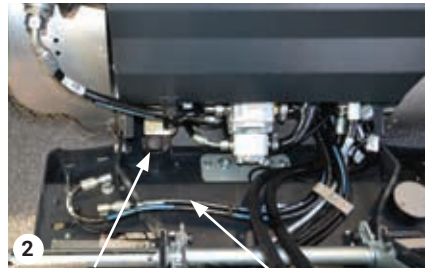

Exhaust Wiring

# General information

## 1.21 Removing the cab/roll bar

1. Remove the doors from the cab to reduce the weight to be lifted (cab only).
2. Remove the air-intake grate on the rear of the front screens.
3. Disconnect the three connectors on the cables leading to the cab/roll bar. (Picture 1)
4. Unscrew the four bolts behind the driver's seat (two on each side), and remove the safety belt and lock. (Picture 2)
5. Loosen the two bolts under the base plate at the front of the machine. (Picture 3)
6. Tip the cabin/roll bar forwards so that the sealing strip can be removed. (Picture 4)

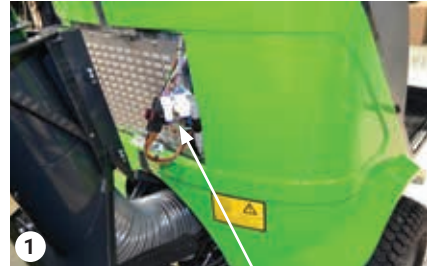

3 connectors behind grate



Loosen the 2 bolts on each side



Bolts under base plate



Remove sealing strip

## 1.21 Removing the cab/roll bar - continued

7. Remove the sealing strip.
8. Pull out the cables. (Picture 1)
9. Tilt the cab/roll bar back into position.
10. Remove the two bolts under the base plate at the front of the machine. (Picture 2)
11. Lift off the cab/roll bar (min. 2 people). (Picture 3)



Pull out the cables



Bolts under base plate



Lift off cab/roll bar

# General information

## 1.22 Fitting the cab/roll bar

1. To fit the cabin/roll bar, lift over the steering wheel and seat.

To reduce lifting weight, remove the doors before lifting the cabin. (Picture 1)

2. Insert the two bolts under the base plate and attach the nuts (but do not tighten). (Picture 2)

3. Tip the cabin/roll bar forwards and chock in place so that the sealing strip can be attached. (Picture 3)

4. Attach a new sealing strip. Ensure that the four bolts behind the driver's seat can be inserted through the holes. Trim off some of the width of the strip adjacent to the holes if necessary.

5. Position spacers. (Picture 4)



Lift cab/roll bar



Bolts under base plate



Chock, attach strip



Position spacers

## 1.22 Fitting the cab/roll bar - continued

6. Insert the cable into position. (Picture 1)
7. Tilt the cab/roll bar back into position.
8. Re-insert the four bolts behind the driver's seat and tighten. Due to tolerances, it may be necessary to guide the holes into the correct position (remember seat belt and lock). (Picture 2)
9. Connect the three connectors on the cables. (Picture 3)
10. Fit the filter and grate.
11. Attach the two rubber strips between the base plate and cab frame (cab only). (Picture 4)
12. Attach the doors to the cab (cab only).
13. If roll bar mounted, remember to fasten topframe of the roll bar. (Picture 5)



Insert the cables



Fit bolts



3 connectors behind grate



Rubber strips



Roll bar

# General information

## 1.23 Trailer

When City Ranger 2260 is equipped with the approved coupling "class A50-X approval no. E2-55R-0112208", the following trailers can be connected:

Trailers without brakes	max.750 kg
Trailers with overrun brakes	max.1.610 kg
Vertical load on trailer coupling (Picture 2)	max.100 kg



### Remark

There is no brake assist system (brake line connection) for trailers on City Ranger 2260. Do not connect trailers with brake assist system to City Ranger 2260.

### Connection of Trailers

**Coupling:** connect the trailer to the coupling and make sure that the connection lock is activated. Lift the support wheel on the trailer.



### NOTE

If the trailer is fitted with overrun brakes, remember to attach the security wire on the trailer to the coupling.

**Light:** to connect the light on the trailer insert the cable plug from the trailer into the connector on City Ranger 2260. Check its function.

**Hydraulics:** if the trailer has a hydraulic tipping function, connect the hydraulic hose to the snap coupling at the rear. (Picture 1)



### Warning

Make sure that no one is standing between the machine and the trailer or near the working area.

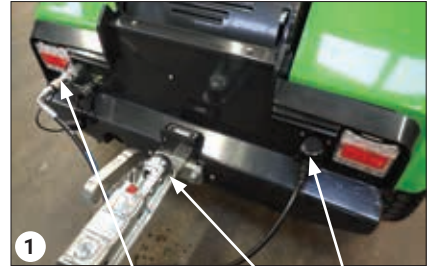

Hydraulic connection    Coupling    Light plug

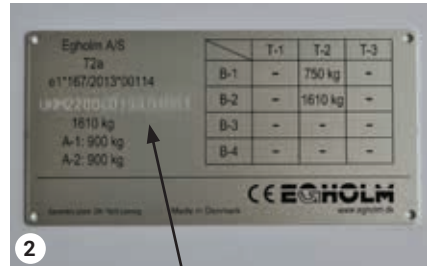

Serial number



Information plate location

# Operator's manual

**Honest  
Machines**

# Operator's manual

## 2.1 Daily checks before start-up

### Open left rear screen

1. Put the release key into the slot. Put light pressure on the side screen and on the release key at the same time. (Picture 1)
2. Open the screen all the way or remove the screen.

### Special attention must be given to the following checks

#### Engine oil

Remove dipstick. (Picture 2)

The oil level must be between the two lines on the dipstick. (Picture 3)

#### Hydraulic oil

When the machine is switched on, the hydraulic oil lamp must not light, see section 9, page 14. If the lamp lights, the hydraulic oil level is too low, top up with hydraulic oil. The hydraulic oil level can also be checked visually on the sight glass of the hydraulic tank (Picture 4). Must be visible in the sight glass. (Picture 4)

Topping-up – see maintenance section 3.4.

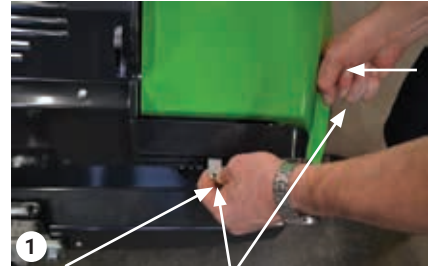

Release key

Light pressure on release key and side screen

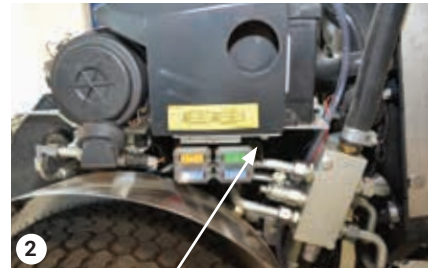

Engine oil – dipstick

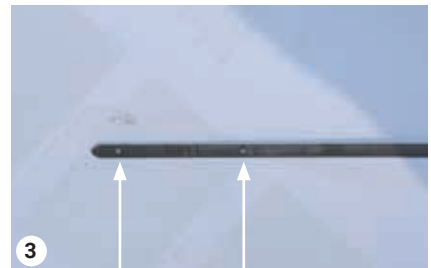

Min. Max.  
Engine oil



Hydraulic oil – sight glass



## 2.1 Daily checks before start-up - continued

### Gasoline

Tank capacity 45 l. (Picture 1)

The Gasoline level lamp (see section 1.6) is on when only 8-10 Litres of Gasoline are left in the tank. (Picture 2)

The Gasoline level lamp will only light when the machine is on.

### Check coolant

Check coolant level at sight glass. (Picture 3)



#### Attention

Never remove the water cover when the engine is hot.



Topping-up gasoline

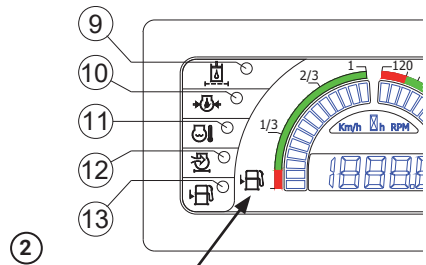

Gasoline level



Expansion tank – check coolant

# Operator's manual

## 2.2 Start, drive and stop

### Rules to follow while driving

- Any person using the vehicle must be sufficiently trained for using and handling the City Ranger 2260.

- Do not drive on a gradient steeper than 12°. However, from experience we know that, under certain conditions, this machine can in fact cope with a steeper incline, max.21° max.10min. (Look at 1.1. Safety, page 7)

- Always drive carefully.

- Do not forget that the City Ranger 2260 is a relatively high and narrow vehicle. Turning should therefore be done at a low speed.

- Do not let the engine run in a closed area: there is a risk of asphyxiation.

- The braking distance of your vehicle increases when the road is wet and/or when your vehicle is loaded.

- Be aware of the steering sensitivity and reactivity.
- Always put on the safety seat belt.
- Never drive with an open door.

- If an alarm lamp is on or flashing when driving, please stop in a safe place and refer to this manual. (see Section 1.6)

- Always adhere to local traffic legislation.

### Before starting the vehicle, the following conditions must be met

1. The PTO front and PTO rear contacts must be disengaged (middle position on switch). (Picture 1)

2. The towing valve must be closed. (Picture 2)

3. Operator must sit in the cab seat.

4. The brake pedal must be pushed all the way down (section 1.9), or the parking brake engaged (section 1.6).



PTO front - PTO rear



Towing valve in closed position

## 2.2 Start, drive and stop - continued

5. Turn the ignition key (clockwise) until the City Ranger 2260 is started.

**Note: if the City Ranger 2260 is started without having the throttle handle in idle position it is not possible to increase rpm before the handle has been in idle position. Engine warning lamp is on.**

6. Release the brake pedal/parking brake.

7. The drive pedal can now be engaged.

Pedal movements:

Forward: Push the pedal down:  
The machine drives forward.  
(Picture 1)

Stop: Neutral position.

Reverse: Press left and down  
The machine reverses.  
(Picture 2)

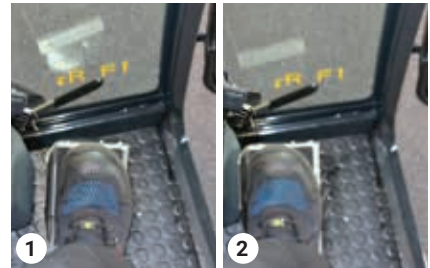

Forward

Drive pedal

Reverse

Speed is variably adjusted. See section 1.9.

### The function of the City Ranger 2260's propulsion system:

- The City Ranger 2260 must be expected to have operating changes within the first 25-50 hours of its lifetime.
- The City Ranger 2260 is developed with controlled deceleration.
- The City Ranger 2260 is featured with hydrostatic propulsion and will react differently when the oil/the machine is cold. The City Ranger 2260 is optimized to run at an operating temperature mode.
- The drive pedal can be used as a brake function. The brake light comes on, if the drive pedal is released quickly.
- The stopping distance varies when the City Ranger 2260 is cold.
- A faint buzzing sound from the drive pedal can occur in some driving situations, and is quite normal.



#### Warning

To protect the hydraulic system, it is important that the machine reaches operating temperature BEFORE the engine is operated at full power.



#### Warning

The City Ranger 2260 is articulated – it turns sharply, immediately. Turn the steering wheel carefully.

# Operator's manual

## 2.2 Start, drive and stop - continued

### Turning off the City Ranger 2260

1. The PTO front and PTO rear contacts must be disengaged.
2. Pull the throttle back so the engine is idling.
3. Push the brake pedal down (Picture 1), lift the parking lock up (Picture 2) and release the brake pedal (See Section 1.6).

4. Turn off the City Ranger 2260 by turning the key back to the key-release position.

### Operating with front attachments

Before the City Ranger 2260 can drive, the fitted attachments must be lifted clear of the ground.

Pull the joystick back until the attachment is lifted all the way. (Picture 3)

If longer transport distances are involved, the transport lock must be activated (See Section 1.6).

### Fitting attachments on the front and back

Read the operator's manual for the relevant attachment(s).

### Connecting and disconnecting attachments

The engine must always be turned off before the attachment is connected/disconnected.

The quick-shift of attachments is not designed to be attached while the engine is running. Incorrect usage will destroy the couplings and will not be covered by the warranty.

The couplings and the area around the couplings must be kept clean to avoid an accumulation of dirt. (See section 3.1)

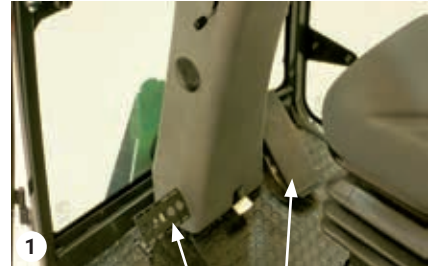

Brake pedal Drive pedal



Transport lock Parking lock



Joystick

## 2.3 Transporting the City Ranger 2260

To transport the vehicle, cross the restraint straps and attach them to the four transport securing rings of the vehicle. (Picture 1+2+3+4)



1 Anchoring at the front



2 Straps at the front



3 Anchoring at the rear



4 Straps at the rear

# Service and maintenance

**Honest  
Machines**

## 3.1 Daily maintenance



### Warning

Before starting any maintenance, turn off engine, remove key and set the main switch in off position.

Daily maintenance of the City Ranger 2260 is simple, easy and very important. Three things are required: Cleaning the water cooler, oil cooler and air filter, and cleaning of the condenser where air conditioning is fitted (See Section 3.3).

### Cleaning the A-frame

Keep the A-frame clean. (Picture 1)

### Cleaning the hydraulics

A-frame. (Picture 2)

1. Turn the locking handle on the A-frame (the same as when connecting an attachment) – the snap couplings are now accessible.
2. Wipe the coupling clean with a soft cloth.
3. Turn the locking handle back.

### B-frame

1. Push the snap coupling spring-loaded protective cover down.
2. Wipe the couplings clean with a soft cloth. (Picture 3)

### Cleaning water/oil cooler (and condenser, if fitted)

1. Open or remove the side screen if necessary. see section 1.17.
2. Using compressed air, clean the cooler fins of the water/oil cooler, and the condenser if fitted. (Picture 4)
3. The cooler fins can be washed with clean water.

### NB! The condensor can be pulled out for cleaning



### Attention

Do not use hard implements or high-pressure cleaners when rinsing the cooler as this may damage the fins.



Top of A-frame



Clean the snap couplings – A-frame



Clean the snap couplings – B-frame



Clean coolers using compressed air

# Service and maintenance

## 3.1 Daily maintenance - continued

### Air filter housing and air filter element

1. Remove the element. Blow it clean with compressed air.
2. Clean the air filter housing with a clean cloth. (Picture 1)



#### Warning

Always switch off the engine before washing the machine.

### Special attention must be given to the following checks

#### Engine oil

Remove dipstick. (Picture 2)  
The oil level must be between the two lines on the dipstick. (Picture 3)

#### Hydraulic oil

When the machine is switched on, the hydraulic oil lamp must not light, see section 9, page 14. If the lamp lights, the hydraulic oil level is too low, top up with hydraulic oil. The hydraulic oil level can also be checked visually on the sight glass of the hydraulic tank (Picture 4). Must be visible in the sight glass. (Picture 4)

Topping-up – see maintenance section 3.4.

### Hydraulic oil, check 3.4 Engine oil, check 3.5



Air filter housing / Filter element

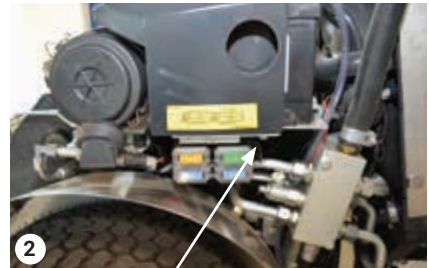

Engine oil – dipstick

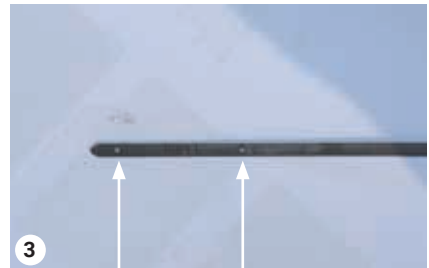

Min. Max.  
Engine oil



Hydraulic oil – sight glass



## 3.2 Lubrication

Cables and movable parts.

Lubricate with a little oil approx. every 15 hours.

Comply with the lubrication intervals. Lubricant: high performance grease K2C30 DIN 51825.

**Grease nipples are located as follows:**

### Greasing the joints

1. Dry away dirt and old grease from the joint.
2. Apply grease gun and pump until new grease appears from the joint.
3. Remove excess grease.
4. Write down the date and hours of operation for future reference.

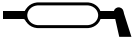

All grease points on the vehicle are marked with this sign:

### Recommendation

A grease gun should be stored in near proximity of the machine in order to minimize the chance of lubrication being skipped.

Greasing point	Description	Acces
1 - 5	Steering cylinder	From underneath
2 - 4	Steering cylinder	From right / left side
3	Articulated joint	From underneath move protection shield
6 - 7	A-Frame cylinder	From underneath

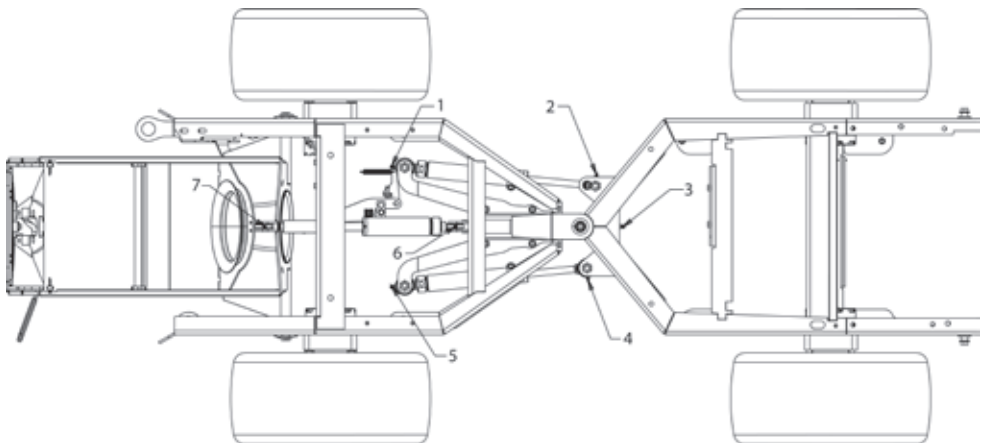

# Service and maintenance

## 3.3 City Ranger 2260 service and maintenance chart

X Lubricate      ◆ Clean      ● Replace      ○ Check

Operation	Service schedule							
	Daily	First 50h	Every 200h	Every 600h	Every 1000h	Every year	Every 2.year	See §
<b>Machine</b>								
Walk-around inspection	○							
Tyre Pressure (1)	○	○	○			○		
Wheel bolts (2)		○	○			○		
Cabin Filter (3)				●		●		
Battery			○			○	●	
Brakes		○	○/X			○/X		
A-frame connections (4)	◆		◆			◆		
B-frame connections (4)	◆		◆			◆		
Lights	○	○	○			○		
<b>Engine</b>								
Air filter, main (3)	◆	○	◆		●	●		
Engine Oil	○	●	●			●		
Engine Oil filter		●	●			●		
Fuel filter	○	○	●			●		
Belt, Alternator		○	○		●	●		
Coolant	○	○	○			○	●	
Coolant hoses and collars		○	○			○		
Water Radiator (3)	◆	○	◆			◆		
Water Radiator pressure cap			○			○		
Engine fan clearance			○			○		
Engine mounts			○			○		
Spark plug			○/◆		●			
Air Intake pipe /clamp bands			○			○		
Breather tube			○			○		
Fuel pipe / Clamps			○			○		
Hand throttle max rpm		○	○			○		
Valve Clearance					○			

# Service and maintenance

## 3.3 City Ranger 2260 service and maintenance chart - continued

Operation	Service schedule							
	Daily	First 50h	Every 200h	Every 600h	Every 1000h	Every year	Every 2.year	See §
<b>Hydraulic</b>								
Hydraulic oil	○	○	○	●		●		
Hydraulic oil filter		●		●		●		
Hydraulic oil cooler (3)	◆	○	◆			◆		
PTO pressure relief valve			○					
Hydraulic hoses		○	○			○		
<b>Air Condition</b>								
AC hoses		○	○			○		
Evaporator			◆			◆		
Evaporator drain hose			◆			◆		
Condensor (3)			◆			◆		
Belt, A/C		○	○		●	●		
Filter dryer, A/C						●		
<b>Lubrication</b>								
Steering cylinder left		X	X			X		
Steering cylinder right		X	X			X		
A-frame lift cylinder		X	X			X		
A-frame lock/cable		X	X			X		
Parking brake cable		X	X			X		

(1) See manual for correct pressure.

(2) Tightning torque.

(3) If the machine is operated in a very hot or dusty environment, more frequent service may be necessary.

(4) Clean all couplings with a clean cloth before mounting any attachment.

# Service and maintenance

## 3.4 Hydraulic system

### Hydraulic oil

The hydraulic oil must be checked when it is cold. The oil must be visible in the sight glass. If the oil is not visible it should be topped-up. (Picture 1)



### Attention

The area around the ventilation and oil inlet must be cleaned BEFORE the oil cover is removed, to prevent potentially damaging dirt and contamination entering the hydraulics.

### Hydraulic oil top-up

1. Park the City Ranger 2260 on a level surface.
2. Switch the engine off.
3. Unscrew filler cap and fill with Texaco HDZ 68 oil or similar. Hydraulic oil must meet NAS and ISO standards, as Texaco HDZ 68.
4. Screw on filler cap.
5. Check that the oil fills half the sight glass when the oil is cold (maximum).

### Tank filter/hydraulic oil filter

The City Ranger 2260 is fitted with a combined filter. The filter is replaced and filter housing cleaned during service. (Picture 2)

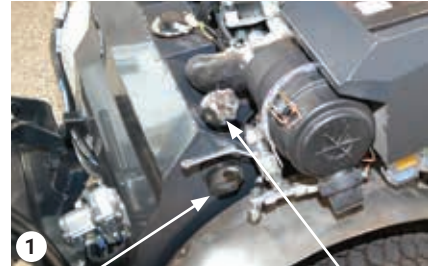

Sight glass

Filling cap

Hydraulic oil



Hydraulic filter

## 3.5 Engine maintenance



### Attention

Always switch off the engine when checking the oil and when changing the oil and the oil filter.

### Engine oil check

1. Park the City Ranger 2260 on a level surface.
2. Check the oil level before the engine starts. (Picture 1)
3. Take the dipstick out, wipe clean in measure area (picture 4) and put it back in.
4. Take the dipstick out again to read the oil level.
5. The oil level must be between the two lines on the dipstick. (Picture 4)
6. Add oil if the oil level is below the bottom line.
7. Always make sure the machine has enough oil.

### Topping-up the engine oil /Filling with engine oil

1. Remove filling cap on engine. (Picture 2)
2. Fill oil until the oil reaches the top line on the dipstick.
3. Wait approx. 5 minutes after adding the oil.
4. Then check the oil level again. It may take a little time for the oil to reach the oil pan.

### Engine oil change

The engine oil should be changed after the first 50 hours of use. Changing the oil is easier when the engine is warm.

The engine is placed in a 9 deg angle and the drain plug is placed in the "high" end of the engine. To be able to drain out all oil the CR2260 must be lifted in a 9 deg angle. Alternative the oil must be sucked out from the oil sump.

1. Remove the drain plug from the oil pan to release the waste oil. (Picture 3)
  2. Remember to replace the drain plug gasket and replace or re-mount the drain plug.
  3. Fill with new engine oil until the level reaches the top line on the dipstick.
- Approx. 3.4 litres if the oil filter has been changed, otherwise approx. 3.1 litres.

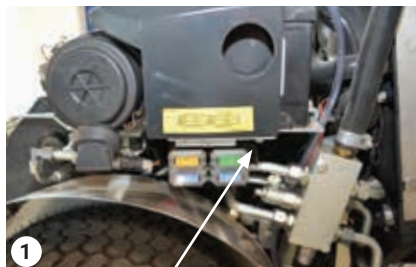

Check the oil level



Engine oil cap

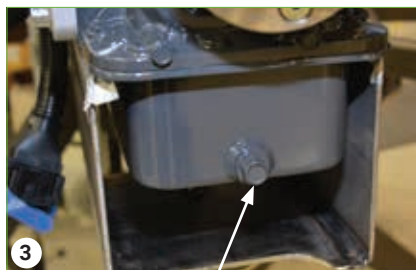

Removing the bottom seal

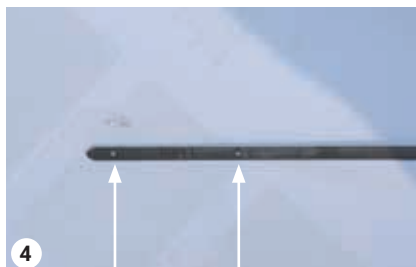

Min.

Max.

# Service and maintenance

## 3.5 Engine maintenance - continued

### Recommendations concerning oil

For best engine performance, we recommend approved Kubota engine oils. Other high-grade oils may be used if they have API, SL or higher

An Engine oil should have properties of API classification, SL or higher.

Change the type of engine oil according to the ambient temperature.

Above 25 C (77 F) SAE30 or SAE10W-30  
SAE15W-40

0 C to 25 C (32 F to 77 F) SAE20 or SAE10W-30

0 C to -20 C (32 F to -4 F) SAE10W or SAE10W-30

When using oil of different brands from the previous one, be sure to drain all the previous oil before adding the new engine oil.

For more information: look at the Kubota manual.

### NB

Lubricating oil viscosity must be suitable for the ambient temperature range for the climate in which the machine is to operate. (Picture 1)

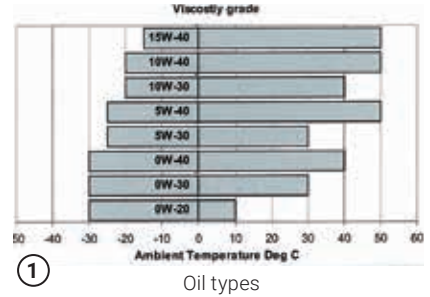

## 3.6 Fuel



### Attention

Always stop the engine before refuelling. Avoid flames and sources of ignition. Gasoline is highly flammable.

### Fuel

Use ONLY Gasoline that meets the following requirements:

Unleaded regular gasoline min. 87 octane.  
E10 (10% ethanol is added to gasoline).

### Note

Low octane has influence on the engine performance

### Fuel tank

The fuel tank is an integrated part of the cab around the seat and joystick console.



### Warning

Never screw a bracket or other object onto the fuel tank.



### Attention

Switch the engine off before checking/replacing fuel hoses.  
Damaged fuel hoses can cause fire.

### Fuel hoses must be checked every time the machine is serviced

1. Check for loose hose clamps – lubricate with a little oil on the clamp screw and tighten.
2. If hoses and hose clamps are worn, they should be immediately replaced.
3. Remove air from the fuel system, if fuel hoses have been replaced.



Gasoline fuel cap



Fuel filter

# Service and maintenance

## 3.7 Cooler



### **Attention** **Removing the cooler cap**

Never remove the cap when the engine is hot, as hot water can escape and cause serious burns. Wait for at least ten minutes after the engine has been switched off and then remove the cooler cap.

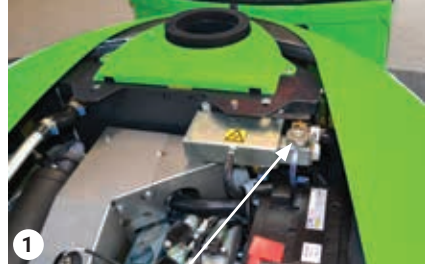

Cooler cap on cooler tank

### **Check the coolant daily**

1. Open right side screen.
2. Check coolant level through sight glass in expansion tank.(Picture 2)



**Attention**  
Always switch the engine off before topping-up with coolant!

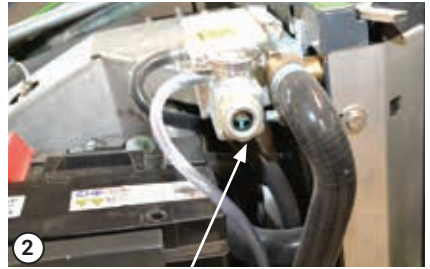

Sight glass

### **Topping-up the coolant**

1. Remove the cooler cap and fill the cooler and tank until approx.  $\frac{3}{4}$  full. Max. capacity approx. 4.2 litres
2. The coolant should consist of 50% pure water and 50% polyethylene glycol, or as prescribed by the manufacturer.
3. Carefully remount the cooler cap.
4. Start the City Ranger 2260 and run the machine until it is sufficiently warm.
5. Switch the engine off and add more coolant. (Picture 1)

### **Important – when filling coolant**

1. After repair  
or
2. After the expansion tank has been empty  
check the bleed valve on the water pump to ensure there is no air in the cooling system.



## 3.7 Cooler - continued

### Preventing overheating

If the warning light is ON, all attachments must be switched off and the engine must be run at half-throttle. The air-intake grill in the rear screen must be cleaned and the source of overheating located. Engine temperature must fall to the normal level within 30 seconds. The engine has a self protecting system if the engine overheats, the engine de-rates. If you are in doubt about the cause, contact your dealer.

### Cleaning the water cooler

Described in section 3.1.

## 3.8 Air filter

### Cleaning the air filter

1. When the City Ranger 2260 is operating in dirty and dusty conditions, open the vacuum valve every day to get rid of larger dirt and dust particles.
2. Open the air filter housing.
3. Remove the filter element.
4. Wipe the air filter housing with a clean cloth.
5. Carefully clean with compressed air from the inside.
6. Put the air filter element back and close the filter housing. (Picture 1)

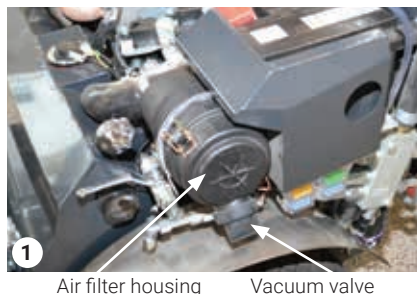

## 3.9 Windscreen washer liquid

During winter, check that the windscreen washer liquid has frost protection properties.

1. The windscreen washer tank is in the cab, behind the driver's seat.
2. Pull the driver's seat forward to access the windscreen washer tank.
3. To add windscreen liquid, unscrew the cap, add windscreen liquid and screw the filling cap on again. (Picture 2)

# Service and maintenance

## 3.10 Battery



### Attention

Observe the following when removing a battery:

1. The machine main switch must be switched off. (Picture 2)
2. Remove the cables from the battery terminals first.
3. Avoid short-circuits across the battery terminals or inadvertently connecting/short-circuiting the battery + terminal to some other part of the machine (Short-circuiting will cause sparks).
4. Avoid sparks, fires, and other sources of ignition. Do not smoke.
5. When the battery is to be reconnected, connect the + terminal first, followed by the - terminal.  
Put on the terminal protection cover.



### Attention

Sulphuric acid is hazardous and can cause loss of sight or serious burns and generates volatile gases.

### Battery charging

The battery charger terminals are connected to the battery so that the + terminal is connected to the battery's + terminal, and the - terminal is connected to the battery's - terminal.

### Battery fluid level

The battery is maintenance free, only check the green lamp on battery. (Picture 4)

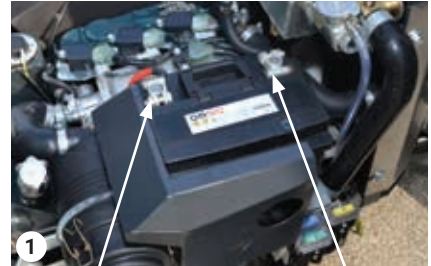

+ terminal Battery - terminal



Main switch – ON



Main switch – OFF



Green lamp  
Battery

## 3.11 Generator V-belt

### Adjustment and tightening

A loose V-belt can result in insufficient charging of the battery.

1. Check the V-belt by pressing the middle section with a finger to see if there is approx. 7–9 mm slack (about 10 kg of pressure).
2. Check the V-belt for wear and tear.

### Tightening

Loosen the two bolts that hold the generator, then adjust/tighten them until the V-belt is at the required tension. Remember to tighten the bolts and nuts after adjusting! (Picture 3)



Jacking point, rear wheel



Jacking point, front wheel

## 3.12 Removal of wheels

Before removing a wheel, the engine must be stopped and the parking brake activated.

Loosen the wheel nuts before the wheel is lifted off the ground.

Jacking point:

- for the rear wheel. (Picture 1)
- for the front wheel. (Picture 2)

When fitting the wheels, tighten the wheel nuts to 100Nm after the machine is lowered to the ground.

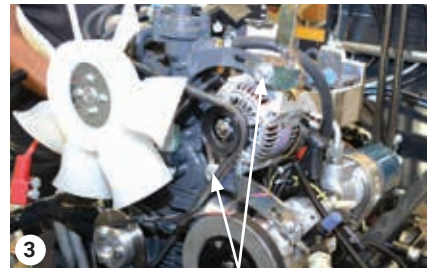

Loosen the two bolts  
Tightening the V-belt



### Attention

After 20 hours of use, tighten the wheel bolts again to 100 Nm. Wheel bolts should not be lubricated.



### Attention

Only use tyre dimension and tyre pressure as specified in section 1.4 page 10.



### Attention

Changing tyres on rims may only be carried out at an authorized workshop.

# Service and maintenance

## 3.13 Cabin filter

Fresh air to the cabin passes through an air filter. The air filter is located behind the grate at the rear of the cab. (Picture 1)

To replace the filter.

1. Remove the grate. (Picture 1)
2. Remove the foam plate.
3. Unscrew the nuts and remove the steel plate and rubber gasket. (Picture 2)
4. Remove the filter element. (Picture 3)

The fitting of the new filter is carried out in reverse order:

- filter element.
- rubber gasket and steel plate.
- foam plate.
- grate.

(Picture 4)



Cabin filter behind grate

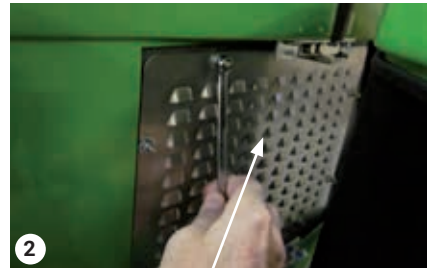

Steel plate and rubber gasket

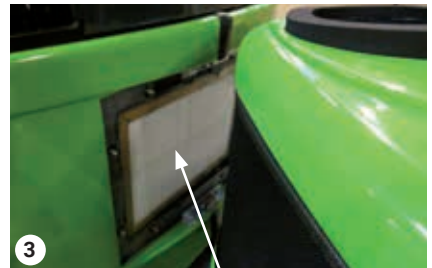

Filter element

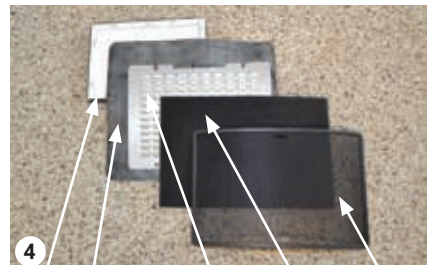

Filter Rubber gasket Steel plate Foam plate Grate

## 3.14 In case of failure



### Attention

Since the City Ranger 2260 is a vehicle with a hydrostatic transmission, it must not be towed more than a few metres, enough to move it out of traffic.

When working on the vehicle, stop the engine, remove the ignition key and pull the parking brake, set the main switch to off. It is also advisable to chock the wheels.

Call your after-sales service and provide the serial number of your City Ranger 2260. You can read it on the information plate of your vehicle. (Picture 1)

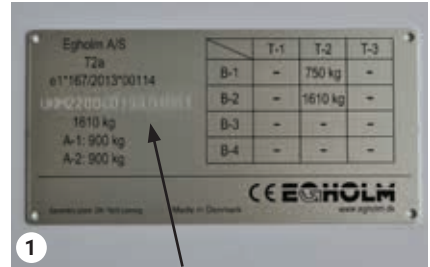

Serial number



Information plate location

## 3.15 Storage

If long term storage is needed make sure to:

- Clean the machine.
- Empty fuel tank.
- Turn main switch to off position.
- Always store in a dry environment.
- Make sure normal maintenance has been carried out prior to storage.

### After storage

- Fill fuel tank with fresh gasoline.
- Turn on main switch.
- Inspect the machine for damage or other issues.
- Check and test brakes.
- Air pressure in tyres.

# Conditions

**Honest  
Machines**

## 4.1 Warranty

The warranty period for the materials and manufacture of this City Ranger 2260 is 12 months from the date of purchase. In case of errors or defects on the machine within the warranty period, Egholm will carry out the necessary repairs without charge for materials and working hours in accordance with the terms and conditions listed below.

### **The scope of the warranty**

1. The Egholm warranty is only valid on presentation of the original receipt supplied with model description, serial number and date of purchase.
2. Regular checks, adjustments, services and technical alterations are not covered by the warranty.
3. All inquiries concerning the warranty are to be addressed to the distributor from whom the machine was purchased.
4. This warranty does not cover faults and defects which cannot be traced back to defects in material or production errors.
5. This warranty is valid for persons who have legally acquired the machine within the warranty period.
6. In the event of failure to perform and substantiate service in accordance with the applicable instructions, Egholm reserves the right to reject any claim made within the warranty period.
7. Egholm reserves the right to make improvements and design-related alterations to the machine without being obliged to modify previously delivered models in relation hereto.

### **The warranty does not cover**

- Wear and tear, accidents, damage to the equipment caused by operating errors, changes to the construction of the machine or use of non-Egholm spare parts or attachments.
- Machines with illegible serial numbers.
- Damage caused by force majeure such as lightning, flood, fire, war, civil disturbance, etc. or other causes over which Egholm has no control.

# Conditions

## 4.2 Complaints

All inquiries regarding the machine should be made at the distributor from whom the machine was purchased. This applies to inquiries concerning normal use, service, maintenance and spare parts as well as any complaints.

We wish you many years of safe and satisfactory use of your machine.

Best regards  
Egholm A/S

## 4.3 Disposal

When, many years from now, your City Ranger 2260 has reached the end of its working life, it should be disposed of in a responsible manner that conforms with relevant disposal regulations.

1. Used hydraulic oil, engine oil, gasoline, coolant and AC coolant are to be delivered at an approved waste disposal facility or site.
2. Remove the plastic and rubber parts and dispose of them in accordance with the applicable environmental legislation.
3. After the parts mentioned have been removed, the machine is ready to be handed over to an approved scrap merchant.



# Wearing parts

**Honest  
Machines**

# Wearing parts

## 5.1 Wearing parts - City Ranger 2260



E50000048 Tyre and wheel 2260



E80700343 Filter kit



E01006500 Air filter 2200/2260



E01022051 Oil filter 2260



E01002000 Hydraulic filter



E01022022 Fuel filter 2260



e70501371 Cab filter 2260  
incl. sealing band

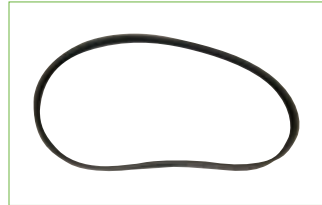

E50007522 AC-belt 2260



E50007148 Drying filter



E01022052 Generator belt 2260

## 5.1 Wearing parts - City Ranger 2260 - continued



E80700344 Drain plug set Plug and gasket



E01022001 Spark plug



E05001140 Lightbulb, main light - 287



E05001180 Bulb front work light



E05001040 Bulb, parking light



E05001010 Bulb for front turn signals



E04501320 Hydraulic couplings A+B frame, 1/4"



E04501330 Hydraulic couplings A+B frame, 3/8"



E04501200 Hydraulic couplings rear tap, male



E04501230 Hydraulic couplings rear tap, female

# Notes



# Notes



# Honest Work.

**Egholm A/S**  
Transportvej 27  
7620 Lemvig, Denmark  
T.: +45 97 81 12 05  
[www.egholm.eu](http://www.egholm.eu) - [info@egholm.dk](mailto:info@egholm.dk)